

Comal Concrete Products, Inc.
4222 FM 482 NEW BRAUNFELS, TX 78132
EMAIL: comalconcrete@comalconcrete.com
830-608-1699 SA Metro: 830-606-4732 Fax: 830-608-1396

1500 GALLON
Lint Interceptor

NOTE: DRAWING NOT TO SCALE

8" TRAFFIC LID (STD)
W/ 2 HOLES 24" DIA.

PLAN VIEW TOP

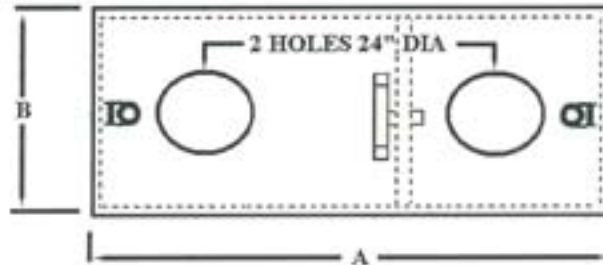

GALLON	DIM. A	DIM. B	DIM. C
1500	151	83	54

SECTION: ELEVATION

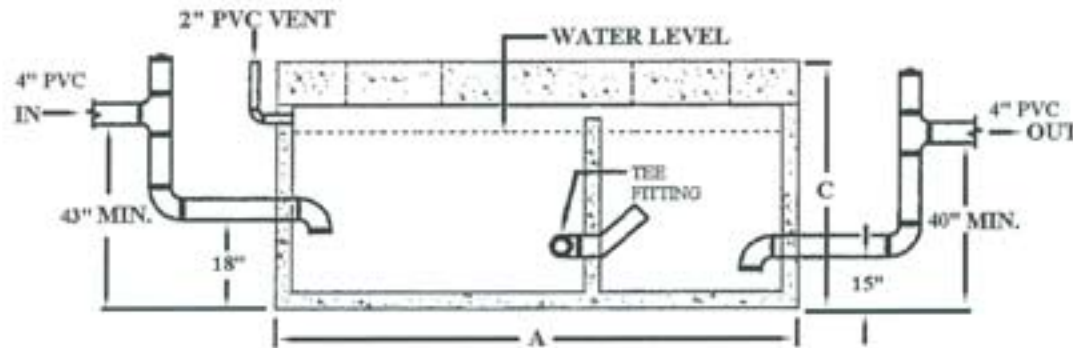

8" TRAFFIC LID (STD)

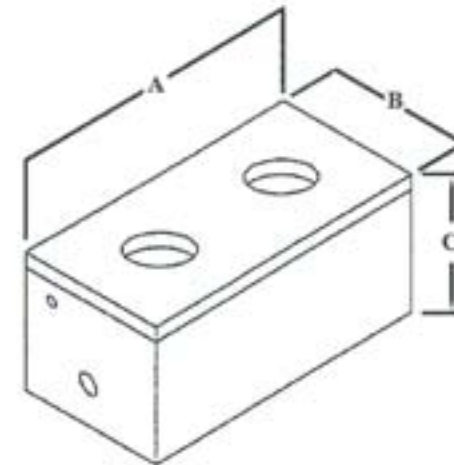

SAN ANTONIO

LOW PROFILE INTERCEPTOR

CONCRETE:

4500 PSI CONFORMING TO ASTM C 150

STEEL REINFORCEMENT:

GRADE 60 CONFORMING TO ASTM A 615

SPECIFICATION:

AASHTO H20-44 8" TRAFFIC LID (STD)

6" TO 8" DEPTH OF PEA GRAVEL BED

RECOMMENDED BY MANUFACTURE

