

**Comal Concrete Products, Inc.**  
**4222 FM 482 NEW BRAUNFELS, TX 78132**  
**EMAIL: comalconcrete@comalconcrete.com**  
**830-608-1699 SA Metro: 830-606-4732 Fax: 830-608-1396**

**6000 GALLON**  
**SAND\_MUD\_OIL INTERCEPTOR**

8" TRAFFIC LID (STD)  
 W/ 2 HOLES 24" DIA.

PLAN VIEW TOP

NOTE: DRAWING NOT TO SCALE

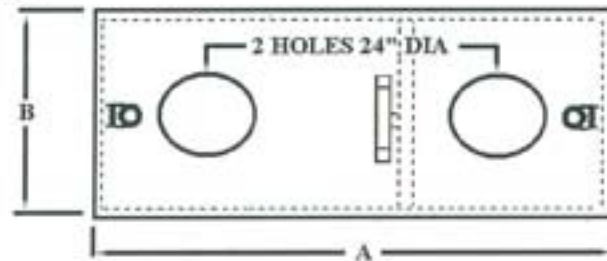

GALLON	DIM. A	DIM. B	DIM. C
6000	216	108	100

SECTION: ELEVATION

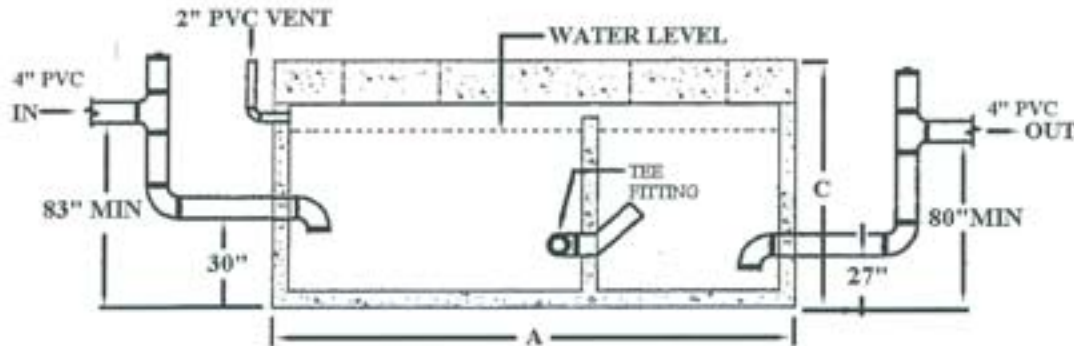

8" TRAFFIC LID (STD)

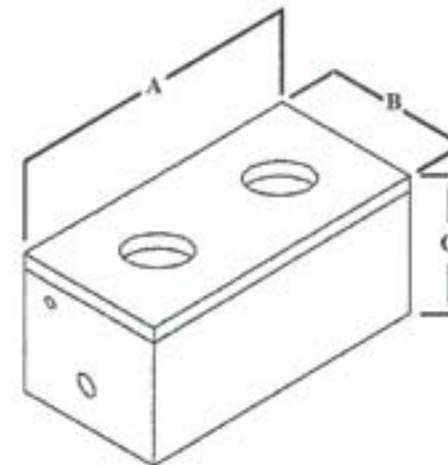

**SAN ANTONIO**

LOW PROFILE INTERCEPTOR

**CONCRETE:**

4500 PSI CONFORMING TO ASTM C 150

**STEEL REINFORCEMENT:**

GRADE 60 CONFORMING TO ASTM A 615

**SPECIFICATION:**

AASHTO H20-44 8" TRAFFIC LID (STD)

6" TO 8" DEPTH OF PEA GRAVEL BED

RECOMMENDED BY MANUFACTURE

